

PS1-A

**TANDHJUL PUMPE
GEAR PUMP**

GR. 1

**STANDARD EU ø25,4 FLANGE
STANDARD EUROPEAN ø25,4 FLANGE**

**KONISK AKSEL 1:8
1:8 TAPER SHAFT**

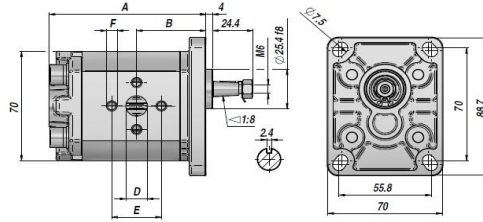
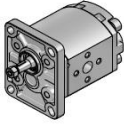

Varenr. Code	Type	cm ³ /omg. cm ³ /rev	P MAX bar		omdr./min rpm		A	B	IN D x E x F	OUT D x E x F	kg
			P1	P3	MAX	MIN					
PG009*001110000	PS1-A 0.9 S/D 10NNO	0.89	240	290	6000	600	73.60	34.80	ø10x26xM5	ø10x26xM5	0.91
PG012*001110000	PS1-A 1.2 S/D 10NNO	1.18	240	290	6000	600	74.70	35.35	ø10x26xM5	ø10x26xM5	0.93
PG016*001110000	PS1-A 1.6 S/D 10NNO	1.60	240	290	6000	400	76.40	36.20	ø10x26xM5	ø10x26xM5	0.95
PG020*001110000	PS1-A 2.0 S/D 10NNO	2.00	220	270	5500	400	77.90	36.95	ø10x26xM5	ø10x26xM5	0.97
PG025*001110000	PS1-A 2.5 S/D 10NNO	2.50	220	270	5000	400	79.90	37.95	ø13x30xM6	ø13x30xM6	1.00
PG032*001110000	PS1-A 3.2 S/D 10NNO	3.20	210	260	4500	400	82.60	39.30	ø13x30xM6	ø13x30xM6	1.04
PG037*001110000	PS1-A 3.7 S/D 10NNO	3.70	210	260	4000	400	84.60	40.30	ø13x30xM6	ø13x30xM6	1.07
PG042*001110000	PS1-A 4.2 S/D 10NNO	4.20	190	230	3500	400	86.50	41.25	ø13x30xM6	ø13x30xM6	1.10
PG050*001110000	PS1-A 5.0 S/D 10NNO	5.00	180	230	3000	400	89.60	42.80	ø13x30xM6	ø13x30xM6	1.14
PG063*001110000	PS1-A 6.3 S/D 10NNO	6.30	170	210	2700	400	94.70	45.35	ø13x30xM6	ø13x30xM6	1.22
PG078*001110000	PS1-A 7.8 S/D 10NNO	7.76	170	210	2500	400	100.40	48.20	ø13x30xM6	ø13x30xM6	1.30
PG098*001110000	PS1-A 9.8 S/D 10NNO	9.78	150	190	2000	400	108.30	52.15	ø13x30xM6	ø13x30xM6	1.41

* 1= ANTICLOCKWISE

* 0= CLOCKWISE

P1 = MAX. ARBEJDSTRYK - MAX. WORKING PRESSURE

P3 = MAX. BELASTNING - MAX. PEAK PRESSURE

FLANGER - AVAILABLE FLANGES

SAE-AA

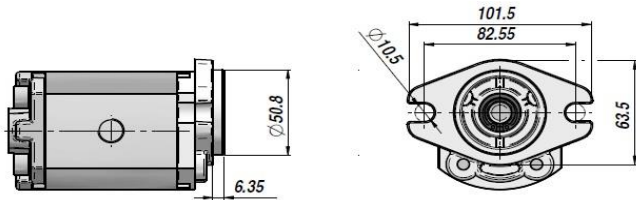

MC 32

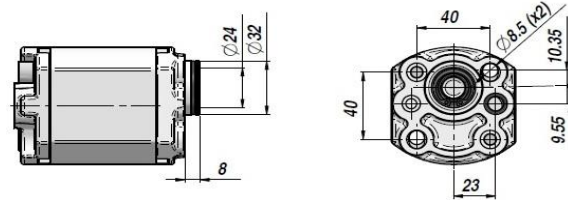

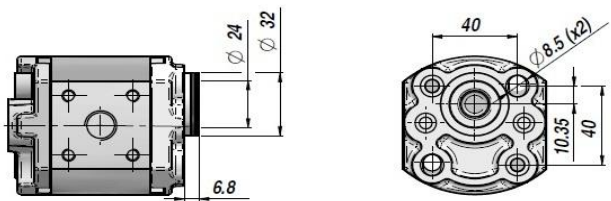

E 32 BX

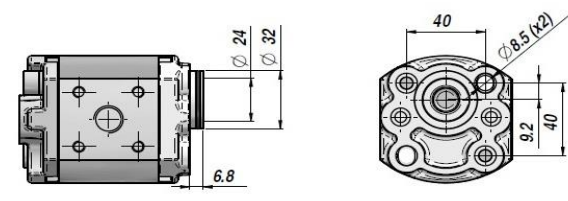

E 32 CX

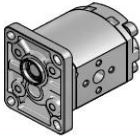

AKSLER - AVAILABLE SHAFTS

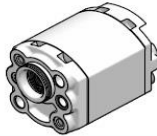
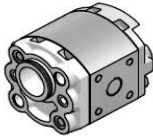
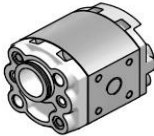
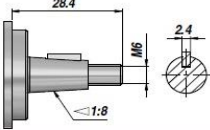
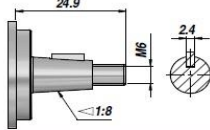
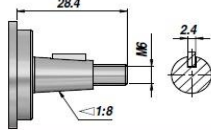
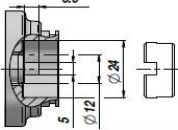
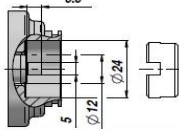
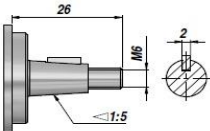
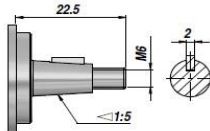
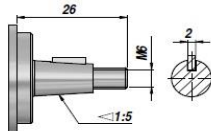
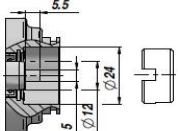
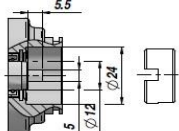
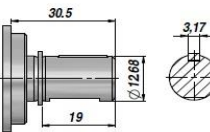
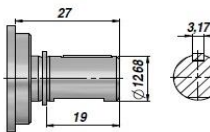
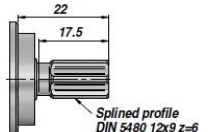
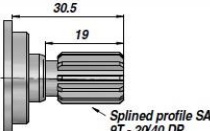
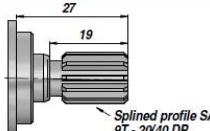
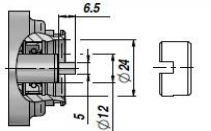
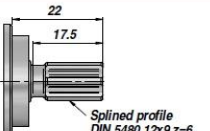
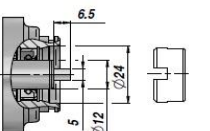
EURO	SAE-AA	MC32	E32BX	E32CX
				
10 	10 	10 	17 	17 
11 	11 	11 	E32BC 	E32CC 
13 	13 	15 		
14 	14 	27 		
15 				
27 				

TILSLUTNINGER - CONNECTIONS

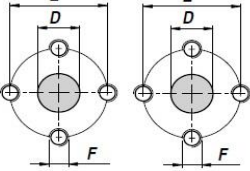
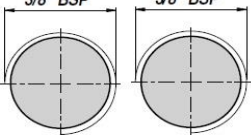
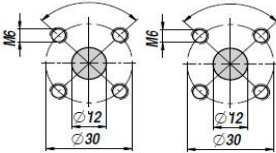
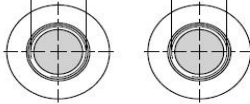
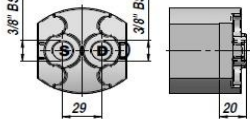
NN (EURO)	GG (GAS)	TT (BOSCH)	UU (UNF)	GG4 (GAS)
<p>Suction Delivery</p> 	<p>Suction Delivery</p> 	<p>Suction Delivery</p> 	<p>Suction Delivery</p> 	<p>S= Suction D= Delivery</p> 
<p>Dimensions : see table on the left</p>			<p>D = 9/16" - 18UNF (cm³ 0.9 ÷ 2.0) D = 3/4" - 16UNF (cm³ 2.5 ÷ 9.8)</p>	